



Kave® Cares



15 min



x1



x1

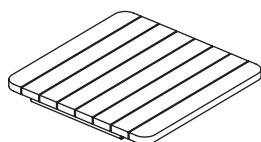

**A** x1

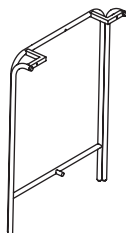

**B** x2



**C** x1



**D** x6  
M8



**E** x6  
M8x40mm



**F** x2  
M6x15mm



**G** x1

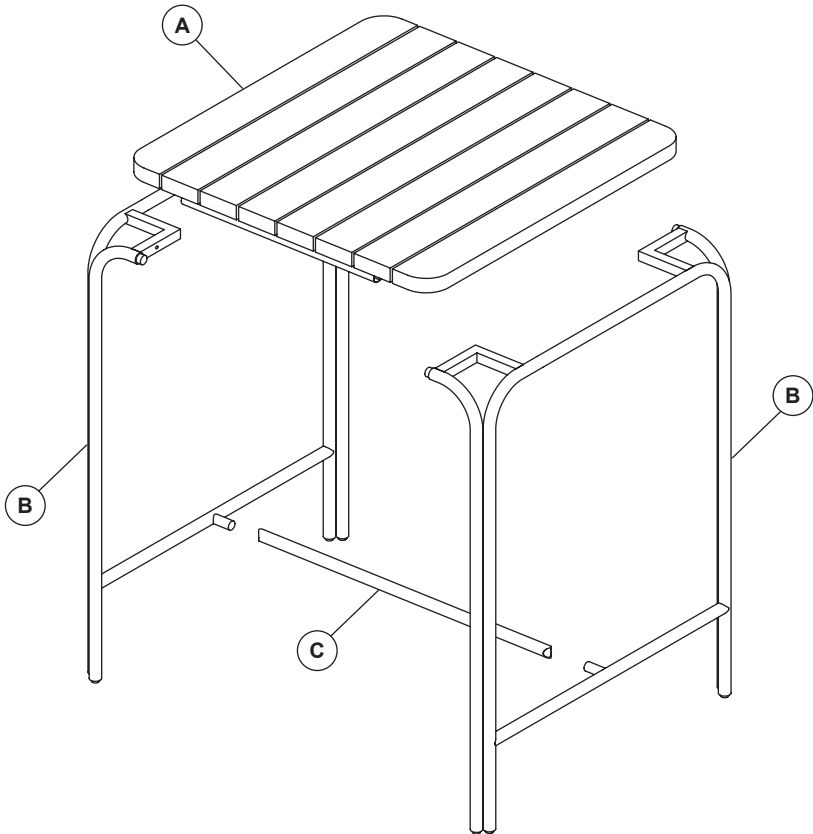

1

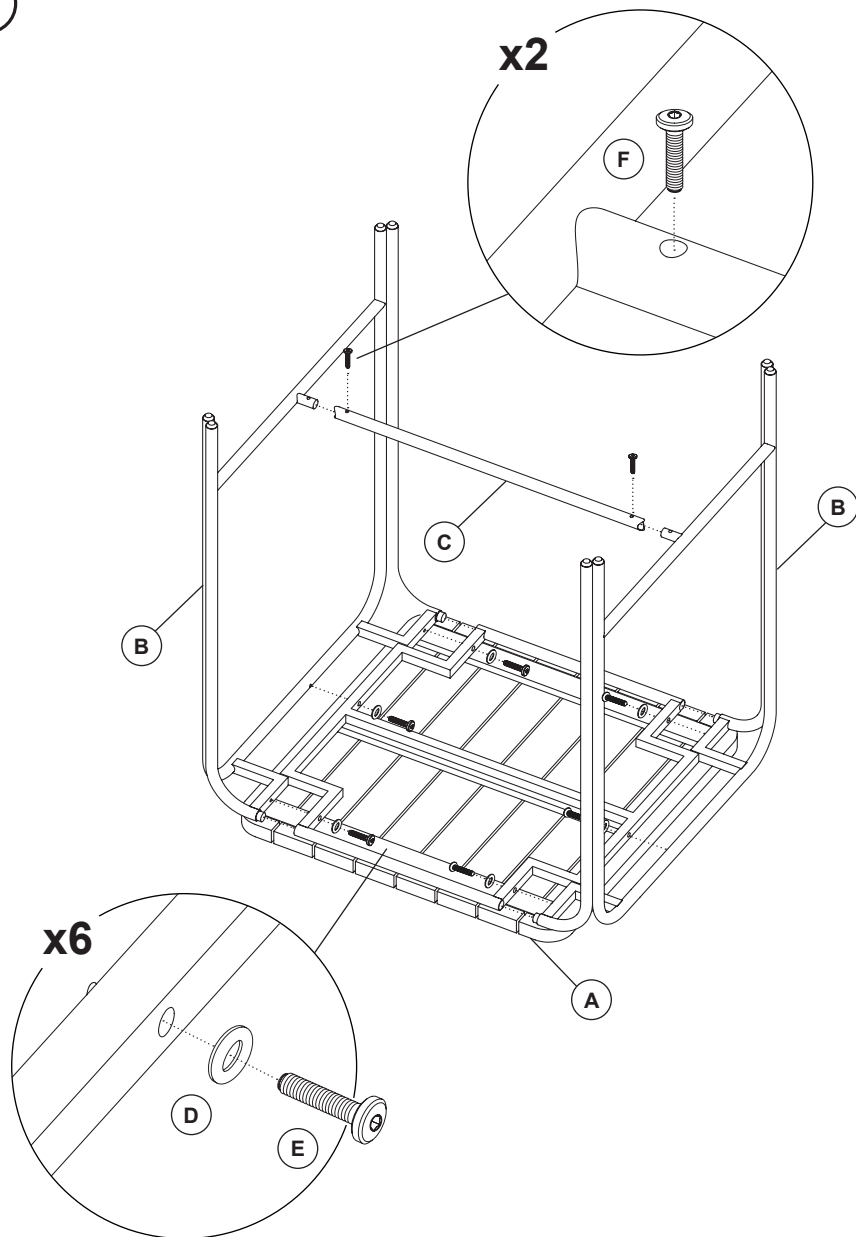

2

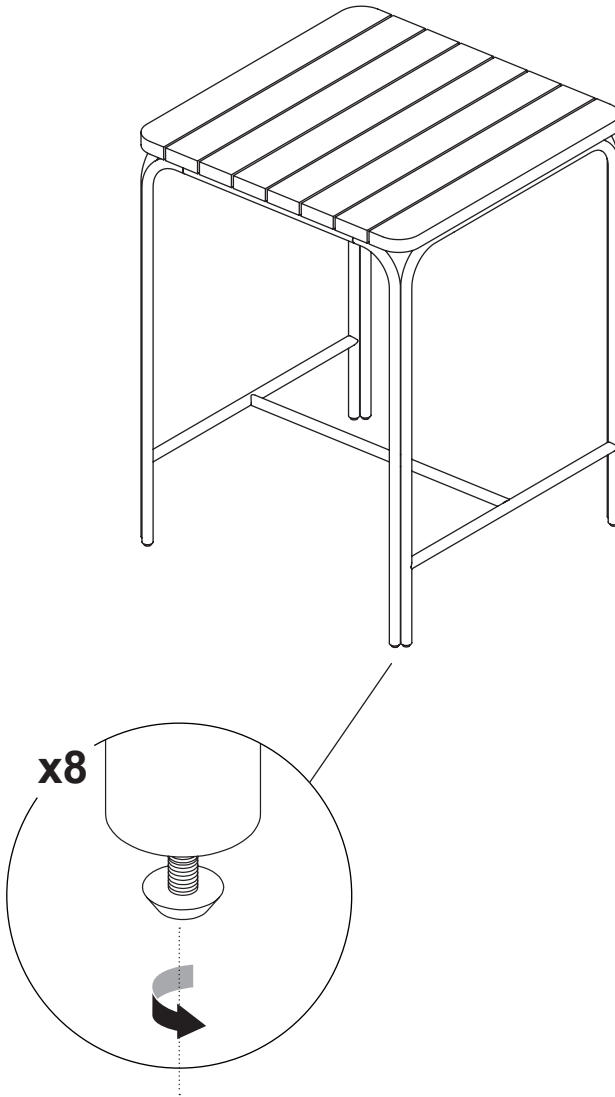

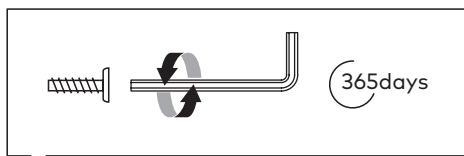
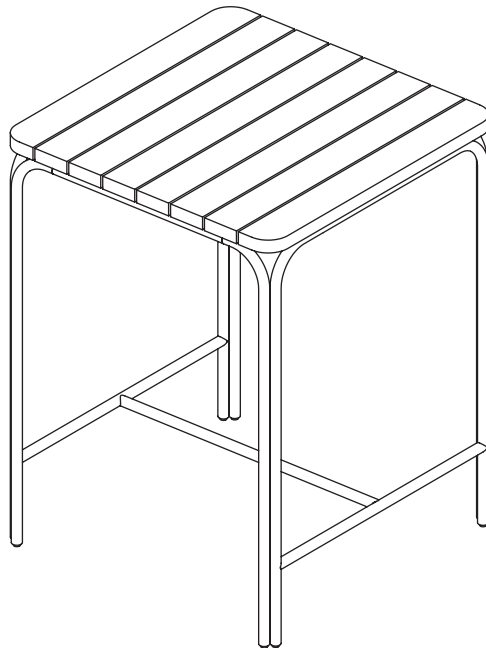



**THAT'S ALL FOLKS**

Share your style!

#KaveHome

