



Kave® Cares



15 min



x1

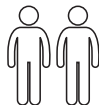

x2

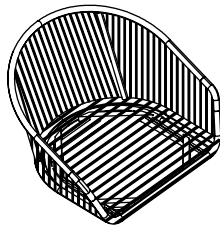

A x1



B x1



C x1



D x1

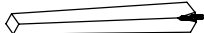

E x1

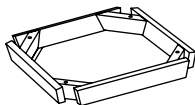

F x1



G x8
M8



H x8
ø8,5mm



I x1

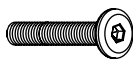

J x4
M6x60mm



K x4
M6



L x1
4mm

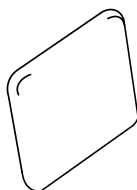

M x1

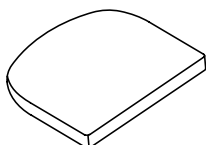

N x1

1

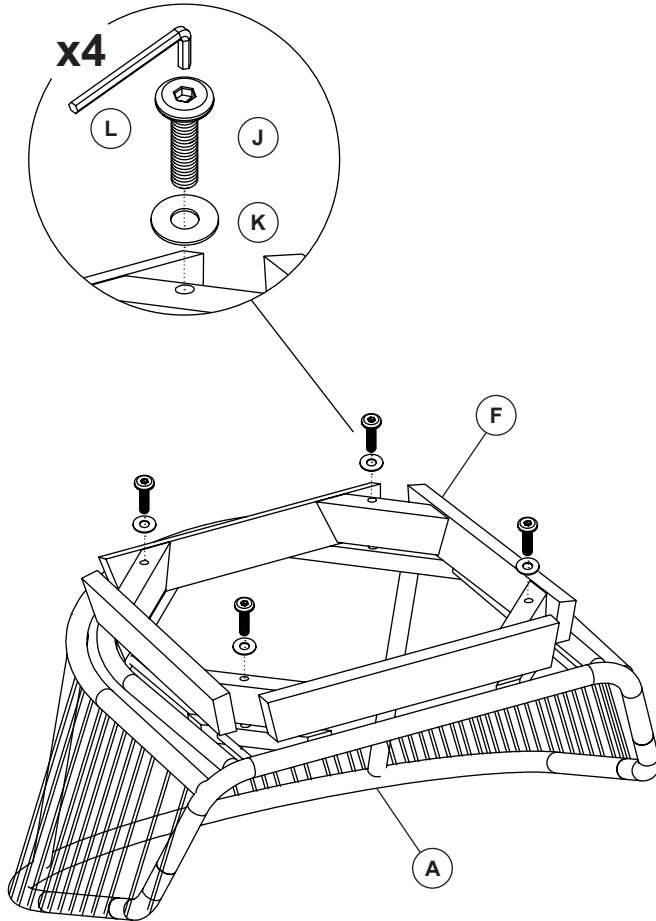

2

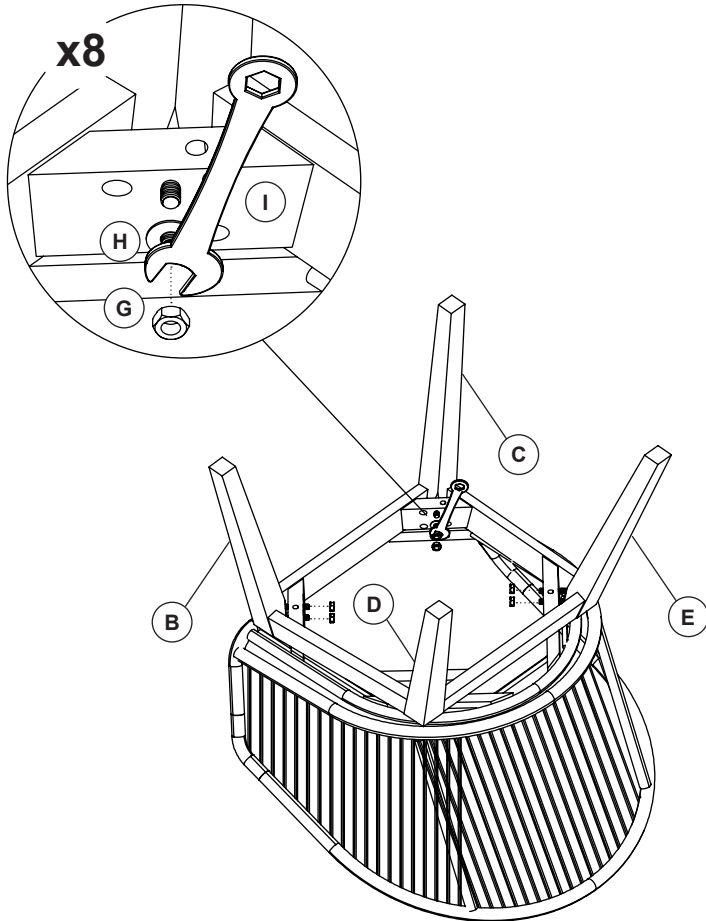

3

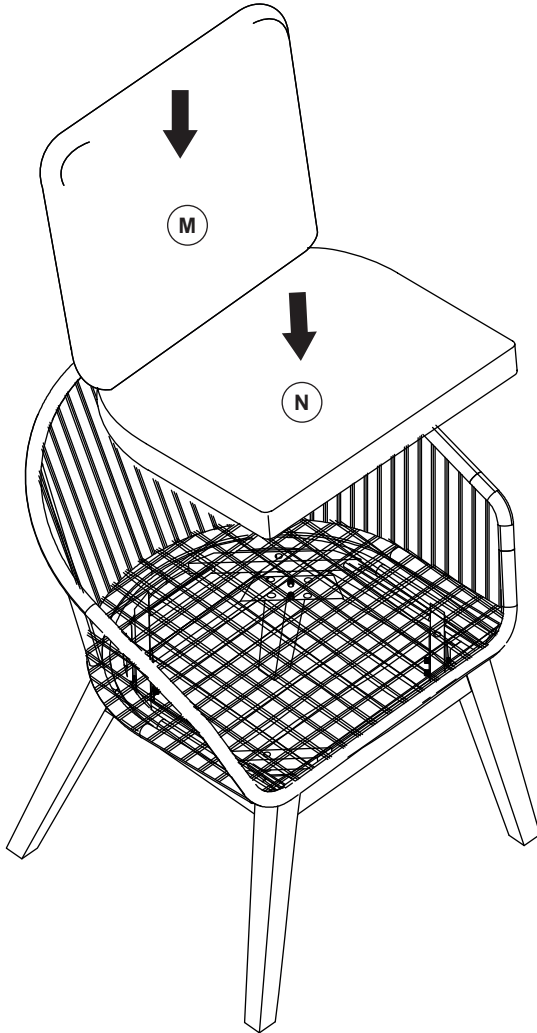

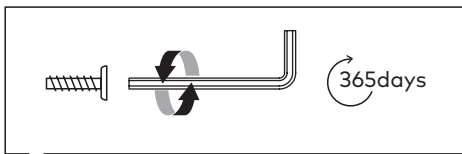
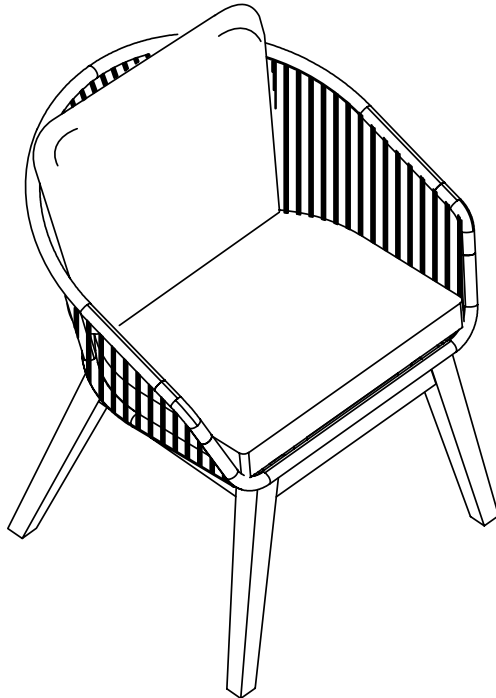



THAT'S ALL FOLKS

Share your style!

#KaveHome

